

PLAN

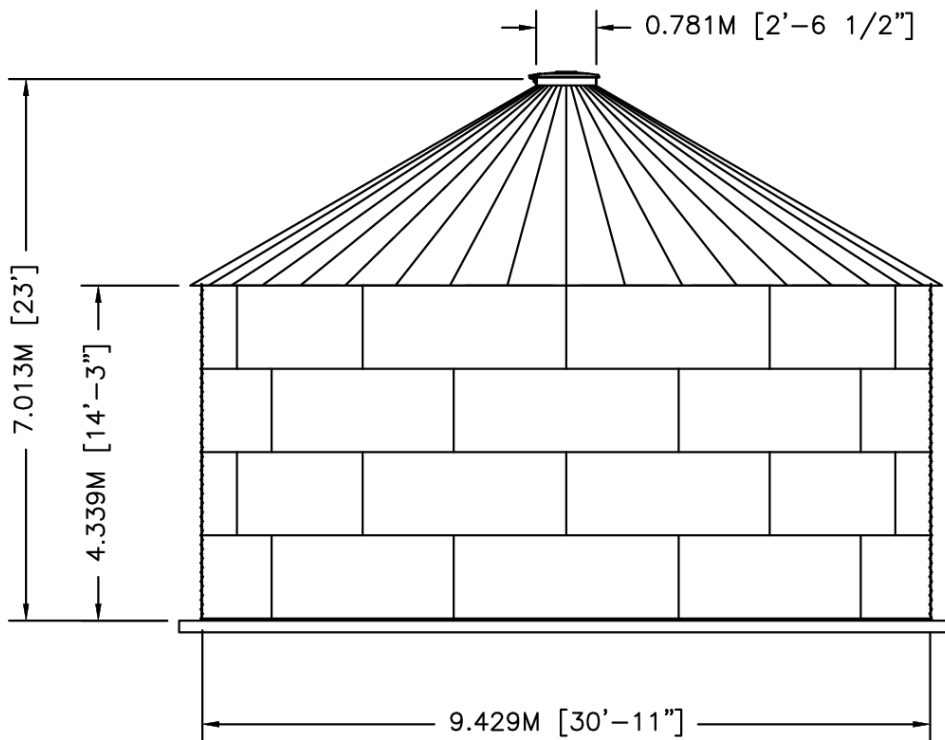

ELEVATION



	BY	DATE	TITLE	
DWN	XXX	XX/XX/XX	WTU10-04 30"PR 30DEG V-RIB	
CKD			NOMINAL CAPACITY - 294.429 M3 [77,780 GAL]	
ENG			DWG. NO. SCT3004-VR WTU10-04	REV. NO.
SIZE:	A	SCALE:	1/8"=1'-0"	SHEET 1 OF 1